

# JVC



**COMPACT COMPONENT SYSTEM**  
**SYSTEME DE COMPOSANTS COMPACT**

## **FS-SD550/FS-SD770/FS-SD990**

**Consist of CA-FSSD550 and SP-FSSD550**

**Consist of CA-FSSD770 and SP-FSSD770**

**Consist of CA-FSSD990 and SP-FSSD990**

**Se compose de CA-FSSD550 et de SP-FSSD550**

**Se compose de CA-FSSD770 et de SP-FSSD770**

**Se compose de CA-FSSD990 et de SP-FSSD990**

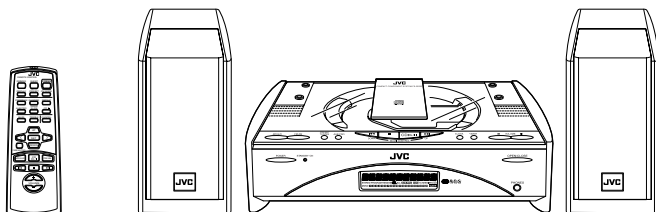

FS-SD550

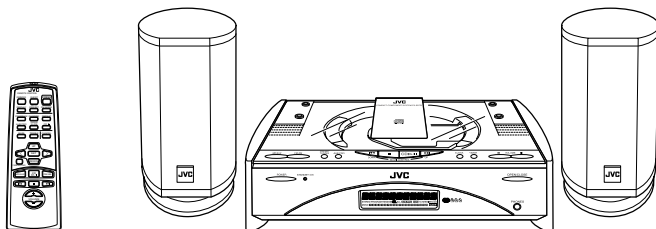

FS-SD770, FS-SD990

**COMPACT**  
**disc**  
**DIGITAL AUDIO**

### **INSTRUCTIONS** **MANUEL D'INSTRUCTIONS**

**For Customer Use:**

Enter below the Model No. and Serial No. which are located either on the rear, bottom or side of the cabinet. Retain this information for future reference.

Model No. \_\_\_\_\_

Serial No. \_\_\_\_\_

GNT0008-013A

[C]

# Warnings, Cautions and Others / Mises en garde, précautions et indications diverses

## IMPORTANT FOR LASER PRODUCTS REPRODUCTION OF LABELS

1. CLASSIFICATION LABEL, PLACED ON EXTERIOR SURFACE
2. WARNING LABEL, PLACED INSIDE THE UNIT

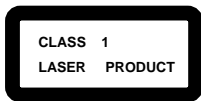

## IMPORTANT POUR LES PRODUITS LASER REPRODUCTION DES ETIQUETTES

1. ÉTIQUETTE DE CLASSIFICATION, PLACÉE SUR LA SURFACE EXTÉRIEURE
2. ÉTIQUETTE D'AVERTISSEMENT PLACÉE À L'INTÉRIEUR DE L'APPAREIL

<b>DANGER:</b> Invisible laser radiation when open and interlock failed or defeated. AVOID DIRECT EXPOSURE TO BEAM. (e)	<b>VARNING:</b> Osynlig laserstrålning när denna del är öppnad och spärrarn är urkopplad. Beträakta ej strålen. (s)	<b>ADVARSEL:</b> Usynlig laserstrålning ved åbning, når sikkerhedsafbrydere er ude af funktion. Undgå udsættelse for stråling. (d)	<b>VARO:</b> Avattaessa ja suo-jälukitus ohitettaessa olet alttina näkymättömälle lasersäteilylle. Älä katso säteeseen. (f)
---	---	--	---

1. CLASS 1 LASER PRODUCT
2. **DANGER:** Invisible laser radiation when open and interlock failed or defeated. Avoid direct exposure to beam.
3. **CAUTION:** Do not open the top cover. There are no user serviceable parts inside the unit; leave all servicing to qualified service personnel.

### CAUTION

To reduce the risk of electrical shocks, fire, etc.:

1. Do not remove screws, covers or cabinet.
2. Do not expose this appliance to rain or moisture.

### CAUTION

#### ■ About the Internal Cooling Fan

This unit includes an internal cooling fan, so as to allow for high-power operation within a small space.

This fan comes on when the sound level is set high, and may also come on even at low sound levels if the internal temperature rises. To ensure effective fan operation, please leave at least 15cm clearance between the rear of the unit and the wall, and at least 1cm clearance on each side of the unit.

1. PRODUIT LASER CLASSE 1
2. **ATTENTION:** Radiation laser invisible quand l'appareil est ouvert ou que le verrouillage est en panne ou désactivé. Éviter une exposition directe au rayon.
3. **ATTENTION:** Ne pas ouvrir le couvercle du dessus. Il n'y a aucune pièce utilisable à l'intérieur. Laisser à un personnel qualifié le soin de réparer votre appareil.

### ATTENTION

Afin d'éviter tout risque d'électrocution, d'incendie, etc.:

1. Ne pas enlever les vis ni les panneaux et ne pas ouvrir le coffret de l'appareil.
2. Ne pas exposer l'appareil à la pluie ni à l'humidité.

### ATTENTION

#### ■ A propos du ventilateur de refroidissement interne

Cet appareil est équipé d'un ventilateur de refroidissement interne afin de permettre un fonctionnement à haute puissance dans un espace limité.

Ce ventilateur se met en marche quand le niveau sonore est élevé et peut aussi se déclencher même à un niveau bas si la température interne augmente. Pour garantir un fonctionnement effectif du ventilateur, veuillez laisser un espace libre de 15 cm au moins entre l'arrière de l'appareil et le mur, et de 1 cm au moins de chaque côté de l'appareil.

#### Caution — POWER switch!

Disconnect the mains plug to shut the power off completely. The POWER switch in any position does not disconnect the mains line. The power can be remote controlled.

#### Attention — Commutateur POWER!

Déconnecter la fiche de secteur pour couper complètement le courant. Le commutateur POWER ne coupe jamais complètement la ligne de secteur, quelle que soit sa position. Le courant peut être télécommandé.

#### For Canada/pour le Canada

**CAUTION:** TO PREVENT ELECTRIC SHOCK, MATCH WIDE BLADE OF PLUG TO WIDE SLOT, FULLY INSERT.

**PRECAUTION:** POUR ÉVITER LES CHOCs ÉLECTRIQUES, INTRODUIRE LA LAME LA PLUS LARGE DE LA FICHÉ DANS LA BORNE CORRESPONDANTE DE LA PRISE ET POUSSER JUSQU'AU FOND

#### For Canada/pour Le Canada

THIS DIGITAL APPARATUS DOES NOT EXCEED THE CLASS B LIMITS FOR RADIO NOISE EMISSIONS FROM DIGITAL APPARATUS AS SET OUT IN THE INTERFERENCE-CAUSING EQUIPMENT STANDARD ENTITLED "DIGITAL APPARATUS," ICES-003 OF THE DEPARTMENT OF COMMUNICATIONS.

CET APPAREIL NUMÉRIQUE RESPECTE LES LIMITES DE BRUITS RADIOÉLECTRIQUES APPLICABLES AUX APPAREILS NUMÉRIQUES DE CLASSE B PRÉSCRITES DANS LA NORME SUR LE MATÉRIEL BROUILLEUR: "APPAREILS NUMÉRIQUES", NMB-003 ÉDICTÉE PAR LE MINISTRE DES COMMUNICATIONS.

# Introduction

Thank you for purchasing the JVC Compact Component System. We hope it will be a valued addition to your home, giving you years of enjoyment. Be sure to read this instruction manual carefully before operating your new stereo system. In it you will find all the information you need to set up and use the system. If you have a query that is not answered by the manual, please contact your dealer.

## Features

Here are some of the things that make your System both powerful and simple to use.

- The controls and operations have been redesigned to make them very easy to use, freeing you to just enjoy the music.
  - With JVC's **COMPU PLAY** you can turn on the System and automatically start the Radio or CD Player with a single touch.
- The System incorporates Active Hyper Bass PRO circuitry to faithfully reproduce low frequency sounds.
- A 45-station preset capability (30 FM and 15 AM) in addition to auto-seek and manual tuning.
- CD options that include repeat, random and program play.
- Timer functions; Daily Timer and Sleep Timer.
- You can connect various external units, such as an MD recorder.
- The system can play CD-R and CD-RW after they have been finalized.
- You can play back your original CD-R or CD-RW recorded in Music CD format. (However they may not be played back depending on their characteristics or recording conditions.)



## How This Manual Is Organized

- Basic information that is the same for many different functions - e.g. setting the volume - is given in the section 'Basic Operations', and not repeated under each function.
- The names of buttons/controls and display messages are written in all capital letters: e.g. FM/AM, "NO DISC".
- System functions are written with an initial capital letter only: e.g. Normal Play.

Use the table of contents to look up specific information you require.

We have enjoyed making this manual for you, and hope it serves you in enjoying the many features built into your System.

## WARNINGS

- **DO NOT PUT ANYTHING ON THE TOP COVER. IF THE SYSTEM IS OPERATED WITH SOMETHING PUT ON THE TOP COVER, IT WILL BE DAMAGED WHEN YOU TRY TO OPEN THE TOP COVER.**
- **NEVER REMOVE THE TOP COVER FROM THE UNIT. SERIOUS INJURY MAY OCCUR IF THE SYSTEM IS OPERATED WITHOUT THE TOP COVER.**

## IMPORTANT CAUTIONS

### 1 Installation of the System

- Select a place which is level, dry and neither too hot nor too cold. (Between 5°C and 35°C or 41°F and 95°F.)
- Leave sufficient distance between the System and a TV.
- Do not use the System in a place subject to vibrations.

### 2 Power cord

- Do not handle the power cord with wet hands!
- Some power is always consumed as long as the power cord is connected to the wall outlet.
- When unplugging the System from the wall outlet, always pull the plug, not the power cord.

### 3 Malfunctions, etc.

- There are no user serviceable parts inside. In case of system failure, unplug the power cord and consult your dealer.
- Do not insert any metallic object into the System.
- Do not insert your hand between the Top Cover and the main body when the Top Cover is being closed.

# Table of Contents

<b>Introduction .....</b>	<b>1</b>
Features .....	1
How This Manual Is Organized .....	1
<b>WARNINGS .....</b>	<b>1</b>
<b>IMPORTANT CAUTIONS .....</b>	<b>1</b>
<b>Getting Started .....</b>	<b>3</b>
Accessories .....	3
How To Put Batteries In the Remote Control .....	3
Using the Remote Control .....	3
Connecting the FM Antenna .....	4
Connecting the AM Antenna .....	5
Connecting the Speakers .....	6
Connecting a Subwoofer .....	7
Connecting External Equipment .....	7
Connecting an MD Recorder, etc (Digital Output) .....	7
Connecting the AC Power Cord .....	8
COMPU Play .....	8
Automatic Power On .....	8
<b>Basic Operations .....</b>	<b>9</b>
Turning the Power On and Off .....	9
Adjusting the Brightness (DIMMER) .....	9
Adjusting the Volume .....	9
Fade-out Muting (FADE MUTING) .....	10
Reinforcing the Bass Sound (AHB PRO) .....	10
Tone Control (BASS/TREBLE) .....	10
Showing the Time (CLOCK/DISPLAY) .....	10
Sliding the Top Cover (DOOR SLIDE) .....	10
<b>Using the Tuner .....</b>	<b>11</b>
Tuning In a Station .....	11
Presetting Stations .....	12
Auto Presetting .....	12
To Change the FM Reception Mode .....	12
<b>Using the CD Player .....</b>	<b>13</b>
To Insert a CD .....	13
To Unload a CD .....	14
Basics of Using the CD Player-Normal Play .....	14
Programming the Playing Order of the Tracks .....	14
Random Play .....	15
Repeating Tracks .....	15
<b>Using External Equipments .....</b>	<b>16</b>
Listening to External Equipment .....	16
Recording the System's Source to External Equipment .....	16
<b>Using the Timers .....</b>	<b>17</b>
Setting the Clock .....	17
Setting the Daily Timer .....	17
Setting the SLEEP Timer .....	19
<b>Care And Maintenance .....</b>	<b>20</b>
<b>Troubleshooting .....</b>	<b>21</b>
<b>Specifications .....</b>	<b>22</b>

# Getting Started

## Accessories

Make sure that you have all of the following items, which are supplied with the System.

- Power Cord (1)
- AM Loop Antenna (1)
- Remote Control (1)
- Batteries (2)
- FM Wire Antenna (1)
- Speaker Cords (2)

If any of these items are missing, contact your dealer immediately.

## How To Put Batteries In the Remote Control

Match the polarity (+ and -) on the batteries with the + and - markings in the battery compartment.

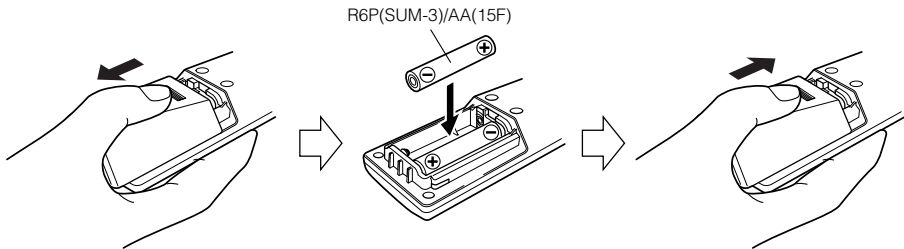

### **CAUTION:**

- Handle batteries properly.

#### ■ To avoid battery leakage or explosion:

- Remove batteries when the Remote Control will not be used for a long time.
- When you need to replace the batteries, replace both batteries at the same time with new ones.
- Do not use an old battery with a new one.
- Do not use different types of batteries together.

## Using the Remote Control

The Remote Control makes it easy to use many of the functions of the System from a distance of up to 7m (23 feet) away. You need to point the Remote Control at the remote sensor on the System's front panel.

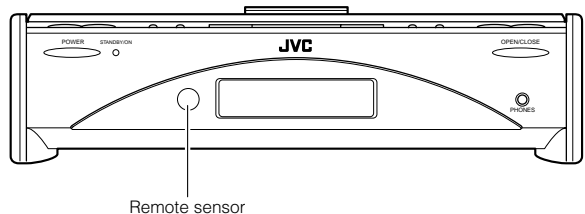

## Getting Started

**CAUTION:**

- Make all connections before plugging the System into an AC power outlet.

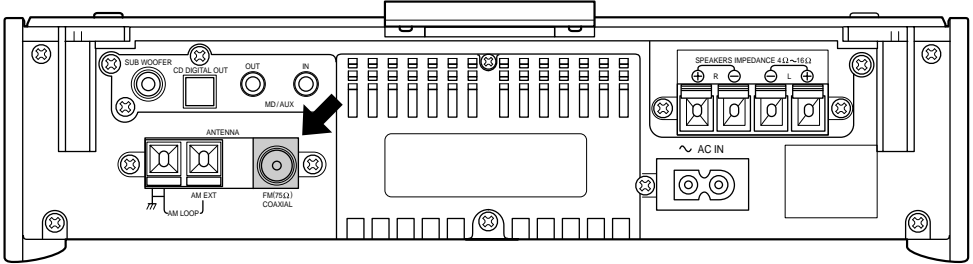
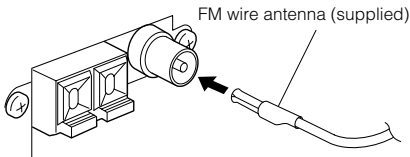
**Connecting the FM Antenna****Rear Panel of the Unit****Using the Supplied Wire Antenna****Note**

- Before attaching a 75 ohm coaxial lead (the kind with a round wire going to an outdoor antenna), disconnect the supplied FM Wire Antenna.

**Using the Coaxial Type Connector  
(Not Supplied)**

A 75-ohm antenna with coaxial type connector should be connected to the FM 75-ohm COAXIAL terminal.

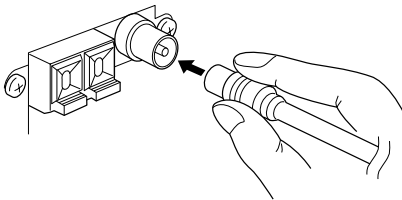

If reception is poor, connect the outdoor antenna.

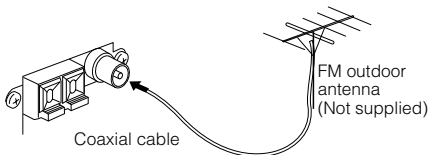

## Connecting the AM Antenna

### Rear Panel of the Unit

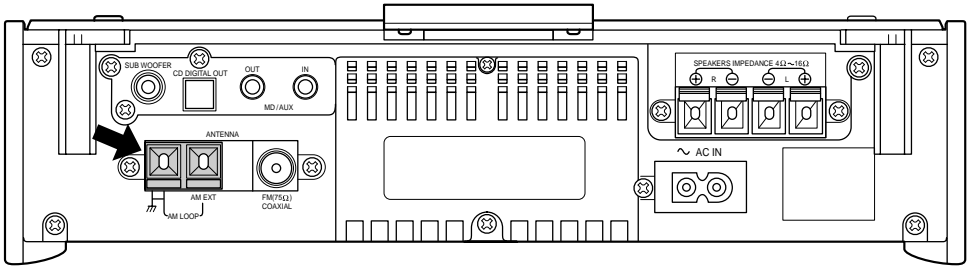

AM loop antenna (Supplied)

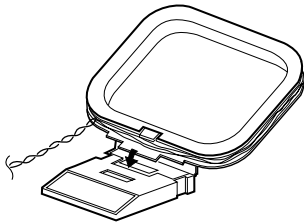

Attach the AM loop to its base by snapping the tabs on the loop into the slot in the base.

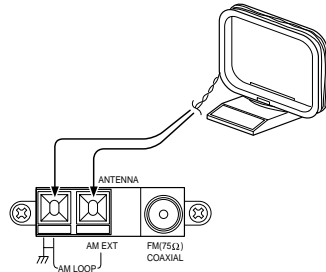

Turn the loop until you have the best reception.

### **CAUTION:**

- To avoid noise, keep antennas away from the System, the connecting cord and the AC power cord.

## Getting Started

### **CAUTION:**

- Make all connections before plugging the System into an AC power outlet.

## Connecting the Speakers

1. Open each of the terminals to connect the speaker wire leads.
2. Connect the speaker cords between the Speaker terminals of the Unit and the terminals of the Speakers.  
Connect the cords with a black line to the (-) terminals and cords without a black line to the (+) terminals.
3. Close each of the terminals to securely connect the cords.

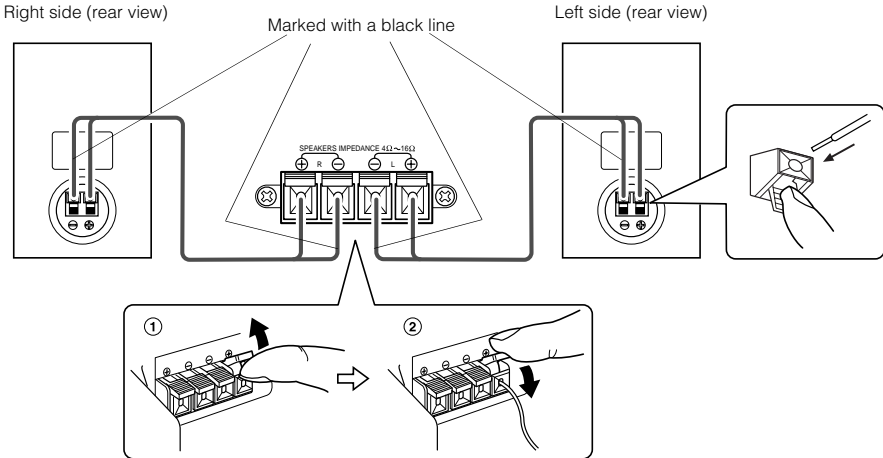

### Note

- Since both speakers are the same, you can put either one to the right or left side.

### **CAUTION:**

- A TV may display irregular colors if located near the speakers. If this happens, set the speakers away from the TV.

## Removing the speaker grilles

The speaker grilles can be moved.

### When removing:

1. Pull the top forwards you with your fingers.
2. Also pull the bottom towards you.

### Note

- When removing the speaker grille from the FS-SD990's speaker, be careful not to damage the cabinet.

(FS-SD550)

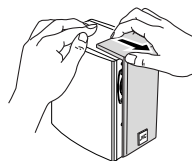

(FS-SD770 and FS-SD990)



(FS-SD550)

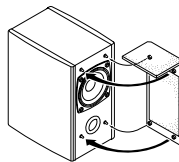

(FS-SD770 and FS-SD990)

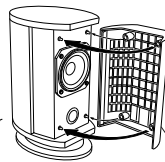

### When attaching the speaker grille:

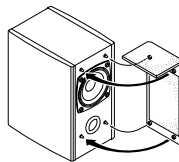

Speaker grille

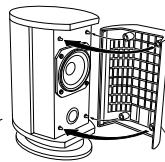

Speaker grille



## Connecting a Subwoofer

Connect a signal cord (not supplied) between the System's SUBWOOFER terminal and the input terminal of an external subwoofer.

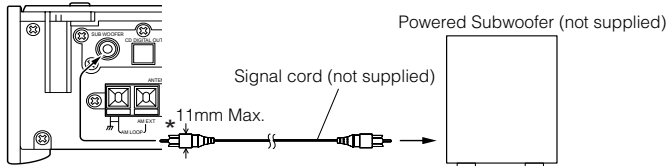

\* Use the plug whose diameter is 11mm or less.

## Connecting External Equipment

Connect signal cords (not supplied) between the System's MD/AUX-OUT/IN terminals and the output/input terminals of the external MD recorder, tape deck, etc.

You can then listen to the external source through the System or record the System's CD player or tuner to the external unit.

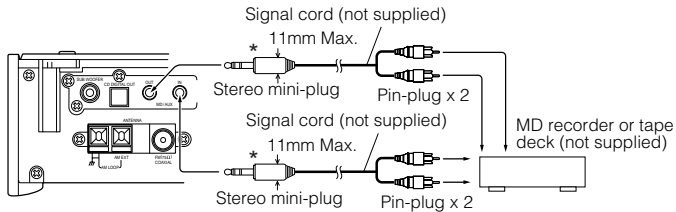

\* Use the plug whose diameter is 11mm or less.

## Connecting an MD Recorder, etc (Digital Output)

Unplug the cap and connect an optical digital cord (not supplied) between the System's CD DIGITAL OUT terminal and the input terminal of the MD recorder, etc.

You can record the digital output signal from the System's CD Player to the MD recorder, etc.

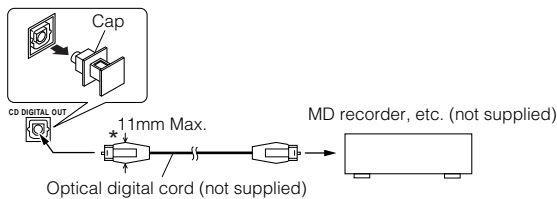

\* Use the plug whose diameter is 11mm or less.

## Getting Started

### Connecting the AC Power Cord

Firmly insert the supplied AC power cord into the AC inlet on the back of the Unit.

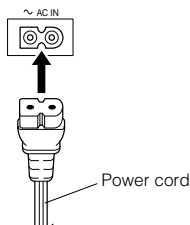

The provided AC power cord for this unit has certain one-way direction connections to prevent electric shock. Refer to the illustration for correct connection.

#### **CAUTIONS:**

- **ONLY USE THE JVC POWER CORD PROVIDED WITH THIS SYSTEM TO AVOID MALFUNCTION OR DAMAGE TO THE SYSTEM.**
- **BE SURE TO UNPLUG THE POWER CORD FROM THE OUTLET WHEN GOING OUT OR WHEN THE SYSTEM IS NOT IN USE FOR AN EXTENDED PERIOD OF TIME.**

Now you can plug the AC power cord into the wall outlet, and your System is at your command!

### COMPU Play

JVC's COMPU PLAY feature lets you control the most frequently used System functions with a single touch.

With One Touch Operation you can play a CD, turn on the radio, or listen to an external equipment with a single press of the play button for that function. One Touch Operation turns the power on for you, then starts the function you have specified. At the same time, the Top Cover moves backward to allow the Unit's top button operation. If the System is not ready (no CD in place), the System still powers on so you can insert a CD.

How One Touch Operation works in each case is explained in the section dealing with that function.

The COMPU PLAY buttons are:

#### On the Remote Control

- CD ▷/|| button
- FM/AM button
- MD/AUX button

### Automatic Power On

The System automatically turns on with the following operation.

- When you press the CD ▲ button on the Remote Control or the OPEN/CLOSE button on the Unit, the System automatically turns on and the Top Cover opens to allow CD setting. However, this operation does not change the function to CD. When you press the POWER button to turn off the System, the Top Cover will be automatically closed if it is opened.
- When you press the DOOR SLIDE button on the Remote Control, the System automatically turns on and the Top Cover moves backwards to allow button operation. When you press the POWER button to turn off the System, the Top Cover will automatically moves back to the original position, if it is in the backward position.

# Basic Operations

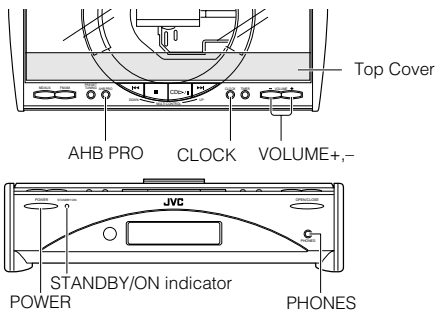
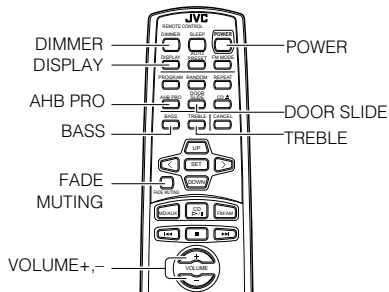

## Turning the Power On and Off

### Turning the System On

Press the **POWER** button.

The Top Cover moves backward and the Unit's top buttons appear. The display comes on and "HELLO" is displayed once. The STANDBY/ON indicator lights in **green**. The System comes on ready to continue in the mode it was in when the power was last turned off.

- For example, if the last thing you were doing was listening to a CD, you are now ready to listen to a CD again. If you wish, you can change to another source.
- If you were listening to the Tuner last, the Tuner comes on playing the station it was last set to.

### Turning the System Off

Press the **POWER** button again.

The Top Cover moves back to the original position. "GOOD BYE" is displayed and the display goes out, except for the clock display. The STANDBY/ON indicator lights in **red**.

- Some power is always consumed even though power is turned off (called Standby Mode).
- To switch off the System completely, unplug the AC power cord from the wall outlet. When you unplug the AC power cord, the clock will be reset to AM 12:00 after about 20 minutes.

## Adjusting the Brightness (DIMMER)

You can adjust the brightness of the backlighting for the display.

### When the System is Turned On

Each time you press the DIMMER button on the Remote Control, the brightness of the backlighting changes as follows:

**Bright** → **Dark** → (back to the beginning)

### When the System is Turned Off (STANDBY MODE)

Each time you press the DIMMER button on the Remote Control, the brightness of the backlighting changes as follows:

**No backlighting** → **Dark backlighting**  
→ (back to the beginning)



- When the System is turned off again after power on, the brightness in Standby mode will be restored to the previous one since the brightness setting in Standby mode is stored in memory.

## Adjusting the Volume

Press the **VOLUME +** button to increase the volume or press the **VOLUME -** button to decrease it.

VOLUME 15

You can adjust the volume level between 0 and 50.

### ⚠ CAUTION:

- **DO NOT turn on the System and/or start playing any source without first setting the VOLUME control to minimum, as a sudden blast of sound could damage your hearing, speakers and/or headphones.**

### For private listening

Connect a pair of headphones to the PHONES jack. No sound comes out of the speakers.

Be sure to turn down the volume before connecting or putting on headphones.

## Basic Operations

### Fade-out Muting (FADE MUTING)

You can mute the output with one touch operation.

**To mute the output**, press the FADE MUTING button on the Remote Control. Then, the output will be faded out and becomes 0.

**To release muting**, press the FADE MUTING button once again. Then, the output will be faded in to the original level.

### Reinforcing the Bass Sound (AHB PRO)

You can reinforce the bass sound to maintain rich, full bass at low volume.

**To get the effect**, press the AHB (Active Hyper Bass) PRO button.

The "AHB PRO" indicator lights up on the display.

**To cancel the effect**, press the button again.

The "AHB PRO" indicator goes out.

### Tone Control (BASS/TREBLE)

You can control the tone by changing the bass and treble.

#### BASS Control

You can adjust the bass level (low frequency range level) between -6 and +6. (0: Flat)

**1** Press the BASS button on the Remote Control.

**2** Press the UP or DOWN button on the Remote Control to adjust the bass level.



#### TREBLE Control

You can adjust the treble level (high frequency range level) between -6 and +6. (0: Flat)

**1** Press the TREBLE button on the Remote Control.

**2** Press the UP or DOWN button on the Remote Control to adjust the treble level.



### Showing the Time (CLOCK/DISPLAY)

You can show the current time on the display.

**To display the clock**, press the CLOCK button on the Unit or DISPLAY button on the Remote Control.

**To return to the previous mode**, press the same button again.

AM 7:00



- To let the clock work, you need to set the clock beforehand. (See "Setting the Clock" on page 17.)

### Sliding the Top Cover (DOOR SLIDE)

Each time you press the DOOR SLIDE button on the Remote Control, the Top Cover slides back and forth.

Slide the Top Cover backward to allow Unit's top button operation. Slide it toward you to cover the buttons.

# Using the Tuner

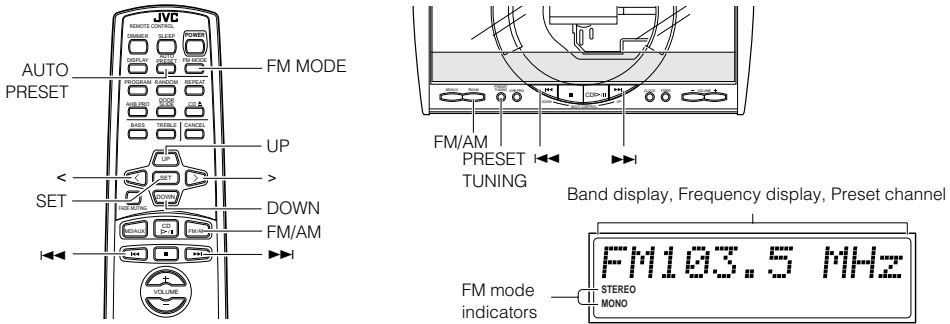

\* When the System is in use, the display shows other items as well.  
For simplicity, we show here only the items described in this section.

You can listen to FM and AM stations. Stations can be tuned in manually, automatically, or from preset memory storage.

- Before listening to the radio:
  - Make sure that both the FM and AM antennas are correctly connected. (See pages 4 and 5).

## One Touch Radio

Just press the FM/AM button to turn on the System and start playing the station you were last tuned to.

- You can switch from any other sound source to the radio by pressing the FM/AM button.

## Tuning In a Station

### 1 Press the FM/AM button.

The Band and Frequency you were last tuned to appear on the display.

(If the last station was selected using the preset number, the preset number appears first.)

Each time you press the button, the band alternates between FM and AM.



### 2 Select a station using one of the following methods.

#### ● Manual Tuning

Press the ◀◀ or ▶▶ button on the Unit or the Remote Control repeatedly to move from frequency to frequency until you find the station you want.

OR

#### ● Auto Tuning

If you press and hold the ◀◀ or ▶▶ button on the Unit or the Remote Control for one second or more, the frequency changes down, or up, automatically until a station is found.

OR

#### ● Preset Tuning using the Remote Control (Possible only after presetting stations)

Select the desired preset number using the UP, DOWN, > and < button on the Remote Control. After 1 second the display will show the preset number's band and frequency.

#### Example:

Press the UP button until the preset number 12 "P12" appears.

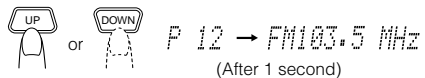

#### ● Preset Tuning using the Unit

Press the PRESET TUNING button to select the desired preset number.

Its band and frequency are displayed.

#### Note

- In AM broadcast, reception sensitivity will be changed by turning the AM loop antenna. Turn the AM loop antenna for best reception.

## Using the Tuner

### Presetting Stations

You can preset up to 30 FM stations and up to 15 AM stations using the Remote Control.

#### Note

- Preset numbers may have been set to factory test frequencies prior to shipment. This is not a malfunction. You can preset the stations you want into memory by following one of the presetting methods below.

### Manual Presetting

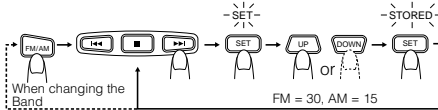

- 1 Select a band by pressing the FM/AM button.
- 2 Press the **◀◀** or **▶▶** button to tune in a station.
- 3 Press the SET button.  
“SET” will blink for 5 seconds.  
Within 5 seconds, proceed to the next step.  
When the display returns to the one set in step 2 after 5 seconds, press the SET button again.
- 4 Press the UP, DOWN, >, or < button within 5 seconds to select the preset number.

UP or DOWN button: Increase or decrease the preset number by 1.

Pressing and holding the button will continuously increase or decrease the preset number.

> or < button: Increase or decrease the preset number by 1.  
Pressing and holding the button will rapidly increase or decrease the preset number.

- 5 Press the SET button within 5 seconds.  
“STORED” appears and after 2 seconds, the display returns to the broadcast frequency display.
- 6 Repeat above steps 1 to 5 for each station you want to store in memory with a preset number.  
To change the preset stations, repeat the same steps as above.

### Auto Presetting

In each band, you can automatically preset FM-30, AM-15 stations. Preset numbers will be allocated as stations are found, starting from the lowest frequency and moving up the frequency.

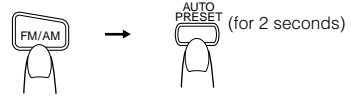

- 1 Select a band by pressing the FM/AM button.
- 2 Press the AUTO PRESET button on the Remote Control for more than two seconds.
- 3 Repeat steps 1-2 for the other band.

- If you want to change the preset stations, carry out the Manual Presetting for the desired preset numbers.

#### CAUTION:

- Even if the system is unplugged or if the power failure occurs, the preset stations will be stored for about 24 hours. However, in case the preset stations are erased, you will need to preset the stations again.

### To Change the FM Reception Mode

When you are tuned into an FM stereo broadcast, the “STEREO” indicator lights up and you can hear stereo effects.

If an FM stereo broadcast is hard to receive or noisy, you can select Monaural mode. Reception improves, but you lose stereo effect.

Press the FM MODE button on the Remote Control so that the “MONO” indicator lights up on the display.

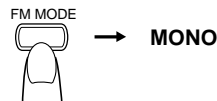

To restore the stereo effect, press the FM MODE button on the Remote Control so that the “MONO” indicator goes off.

# Using the CD Player

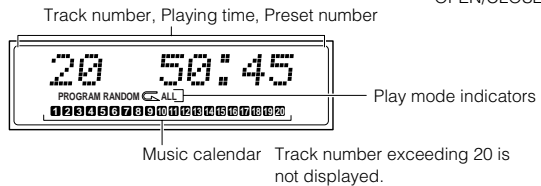
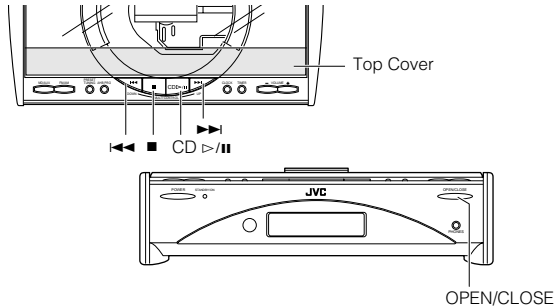
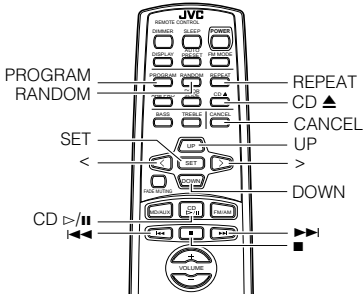

\* When the System is in use, the display shows other items as well.  
For simplicity, we show here only the items described in this section.

You can use Normal, Random, Program or Repeat Play. Repeat Play can repeat all the tracks or just one of the tracks on the CD.  
Here are the basic things you need to know to play a CD and locate the different tracks on it.

This unit has been designed only to playback the CDs bearing the marks.



## When playing a CD-R or CD-RW

You can play back finalized CD-R or CD-RW recorded music CD format.

- You can play back CD-R or CD-RW like CD.
- Some CD-R or CD-RW may not be played back on this unit because of their disc characteristics, damage or stain on them, or if the player lens is dirty.
- The reflection factor of CD-RW is lower than that of other CD, possibly causing CD-RW to take longer to read.

## The Quickest Way To Start a CD Is With the One Touch Operation

- Press the CD play/pause button on the Remote Control.
- The power is automatically turned on and the Top Cover moves backward to allow the Unit's top button operation. If a CD is already inserted, it will start playing from the first track.
- If no CD is inserted, "NO DISC" appears on the display and the CD Player remains in Stop mode.

## To Insert a CD

- 1 Press the OPEN/CLOSE button on the Unit (or the CD play/pause button on the Remote Control).**  
The Top Cover opens.
- 2 Place a CD, with its label side up as shown below. Press down on the CD's center until you hear a click.**



- 3 Press the OPEN/CLOSE button (or CD play/pause button) again to close the Top Cover.**
  - To close the Top Cover and play the CD, you can just press the CD play/pause button.

- You can place an 8 cm (3") CD without an adaptor.
- If the CD cannot be read correctly (because it is scratched, for example), "00:00" appears on the display.
- You can insert a CD while listening to the other source.

## CAUTION:

- **DO NOT try to open or close the Top Cover by hands as it will be damaged.**

## Using the CD Player

### To Unload a CD

Take out the CD as shown below.

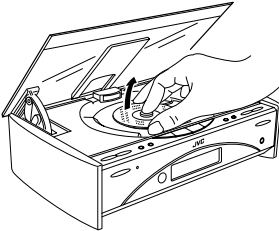
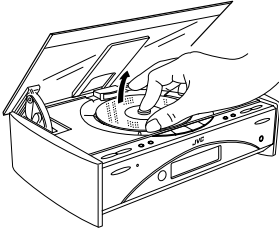

### Basics of Using the CD Player-Normal Play

#### To Play a CD

- 1 Insert a CD.
- 2 Press the CD ▷/|| button.

The first track of the CD begins playing.

1      0:05  
|      |  
Track number    Playback time

- The track number that has already played disappears from the music calendar.
- The CD Player automatically stops when the last track of the CD has finished playing.

To stop playing the CD, press the ■ button. The following information for the CD is displayed.

18    50:45  
|      |  
Total track number    Total playback time

To stop playing and remove the CD, press the OPEN/

CLOSE button on the Unit or CD ▲ button on the Remote Control to open the Top Cover.

To pause, press the CD ▷/|| button. The playback time blinks on the display.

To cancel pause, press the same button again. Play continues from the point where it was paused.

### To Select a Track or Passage within a Track

During playback, press the ◀◀ or ▶▶ (◀ or ▶) button to select the track you want.

- The selected track starts playing.
- Press the ▶▶ or > button once to skip to the beginning of the next track.
- Press the ◀◀ or < button to skip to the beginning of the track being played. Press twice quickly to skip to the beginning of the previous track.
- When the > or < button on the Remote Control is kept pressing, the track continuously skips.

### Search Play

Holding down the ◀◀ or ▶▶ button, during playback, will fast forward/backwards the CD so you can quickly find a particular passage in the track you are listening to.

### Programming the Playing Order of the Tracks

You can program the playing order of the tracks using the Remote Control.

- You can program up to 32 tracks in any desired order including the same tracks.
- You can only make a program when the CD Player is stopped.

- 1 Insert a CD.
- 2 Press the CD ▷/|| button.
- 3 Press the ■ button to stop the CD.
- 4 Press the PROGRAM button.

The System enters the programming mode and the "PROGRAM" indicator lights up.



- 5 Press the UP, DOWN, >, or < button to select the track to program.

UP or > button: Increases the track number by 1.  
DOWN or < button: Decreases the track number by 1.

- When the > or < button is kept pressing, the track number changes rapidly.

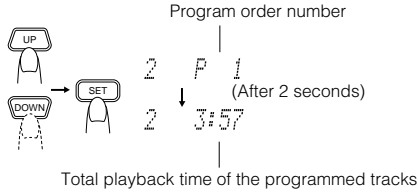

**6 Press the SET button.****7 Repeat steps 5 and 6 to select the other tracks for the program.**

You can see the total playback time of programmed tracks on the display. Also, you can see the programmed tracks on the music calendar.

**8 Press the CD ▷/II button.**

The System plays the tracks in the order you have programmed them.

■ You can skip to a particular program track by pressing the ◀◀ or ▶▶ button during Program Play.

■ To stop playing, press the ■ button once.

**To confirm the programmed tracks while the CD player is stopped**, each time press the ◀◀ or ▶▶ button; the tracks making up the program will successively be displayed in the programmed order.

**To delete all the tracks in the program**, in stop mode, press the ■ button. Pressing the CD ▲ button to open the Top Cover will also clear the programmed tracks.

**To exit the program mode once**, while the CD Player is stopped, press the PROGRAM button to light off the "PROGRAM" indicator.

**Notes**

- If the total playback time of the programmed tracks exceeds 99 minutes 59 seconds, the total playback time will go out on the display.
- If you try to program the 33rd track, "MEMORY FULL" appears on the display for about 2 seconds.

**To Modify the Program**

Modify the contents of the program while the CD Player is stopped.

Each time you press the CANCEL button, the last track in the program is deleted. To add new tracks to the end of the program, repeat above steps 5 to 7.

**Random Play**

The tracks will play in no special order when you use this mode.

**1 Press the RANDOM button on the Remote Control.**

The "RANDOM" indicator lights up on the display.

**2 Press the CD ▷/II button.**

The tracks are played in random order.

**To skip a track during playback**, press the ▶▶ button to jump to the next track in the random sequence. Press the ◀◀ button to jump back to the start of a track being played.

**To exit Random Play mode**, while the CD Player is stopped, press the RANDOM button to light off the "RANDOM" indicator and carry out Normal Play, or press the CD ▲ button to open the Top Cover.

**Repeating Tracks**

You can repeat all tracks or individual track, as many times as you like.

**Press the REPEAT button on the Remote Control.**

The Repeat indicator changes with each press of the button, as shown below.

☐ → ☐ ALL → blank display → (back to the beginning)

☐ : Repeats one track.

☐ ALL: In Normal Play mode, repeats all the tracks. In Program Play mode, repeats all the tracks in the program.

In Random Play mode, repeats all the tracks in random order.

**To exit Repeat mode**, press the REPEAT button until the Repeat indicator on the display goes out.

■ In Random Play, ☐ cannot be selected.

■ Repeat mode remains in effect even when you change the play mode.

# Using External Equipments

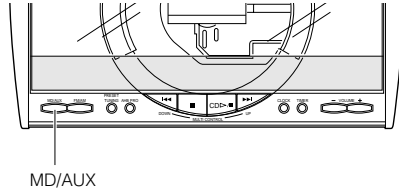
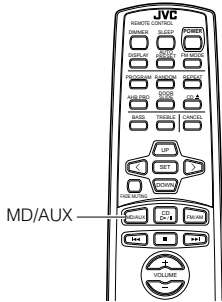

## Listening to External Equipment

You can listen to external equipment such as MD recorder, turntable or other auxiliary.

- First make sure that the external equipment is properly connected to the System. (See page 7).

- 1 Set the VOLUME control to the minimum position.**
- 2 Press the MD/AUX button.**  
“MD/AUX” appears on the display.

**MD/AUX**

- 3 Start playing the external equipment.**
- 4 Adjust the VOLUME control to the desired listening level.**
- 5 Apply sound effects, if you wish.**

- Press the AHB PRO button to reinforce the bass sound.
- Press the BASS/TREBLE button on the Remote Control to control the tone. (See “Tone Control” on page 10.)

**To exit MD/AUX mode**, you will automatically switch out of MD/AUX mode when you select another source.



- For operation of the external equipment, refer to its Instructions.

## Recording the System's Source to External Equipment

You can record the System's source to external equipment which is connected to the MD/AUX-IN/OUT or CD DIGITAL OUT terminals of the System, such as cassette deck or MD recorder, etc.

- First make sure that the external equipment is properly connected to the System. (See page 7).

- 1 Play the System's CD Player or tune in to a station.**
- The recording level is not affected by the VOLUME level set by the System. Also it is not affected by the sound effects.



- For operation of the external equipment, refer to its Instructions.

# Using the Timers

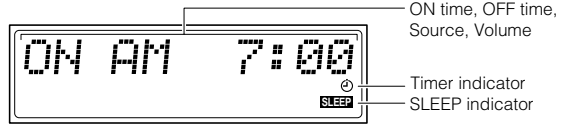
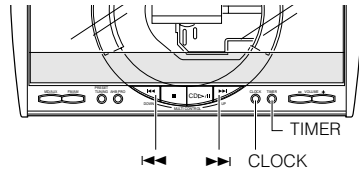
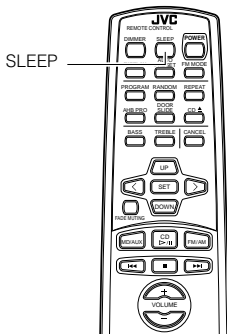

\* When the System is in use, the display shows other items as well. For simplicity, we show here only the items described in this section.

The timers let you control listening functions automatically.

## Setting the Clock

- Use the Unit's button to set the clock.
- When you plug the AC power cord into the wall outlet, the time indication "AM 12:00" blinks on the display.

### Notes

- The clock must be correctly set for the timers to work.
- The procedure must be completed within **two minutes**. Otherwise, the setting is cleared and must be repeated from the beginning.

### 1 Press the POWER button.

Then, the Unit's top buttons appear.

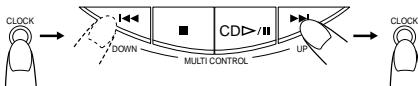

(for 2 seconds)

### 2 Press the CLOCK button on the Unit for more than two seconds.

The hour digit of the time indication rapidly blinks on the display.

### 3 Press the ►► or ◀◀ button on the Unit to set the hour.

Pressing the ►► button moves the time forwards and pressing the ◀◀ button moves it backwards. Hold down the button to move the time rapidly.

### 4 Press the CLOCK button.

The minute digits of the time indication rapidly blink on the display.

### 5 Press the ►► or ◀◀ button to set the minute.

### 6 Press the CLOCK button.

The selected time is set and the seconds start counting from 0.

### CAUTION:

- If there is a power failure, the clock loses its setting after about 20 minutes. "AM 12:00" blinks on the display and the clock must be reset.

### Note

- The clock may gain or lose one to two minutes per month.

## Setting the Daily Timer

Once you have set the Daily Timer, the timer will be activated at the same time every day.

The Timer indicator on the display shows that the Daily Timer you have set is in effect.

- Use the Unit's button to set the timer.

### Note

- Perform each setting within 30 seconds. Otherwise, setting will be cleared and the procedure must be repeated from the beginning.

## Using the Timers

### 1 Setting the ON time (Example: AM 10:15).

1. Press the TIMER button on the Unit for more than two seconds.  
The Timer indicator lights up and the hour digit of the current ON time blinks on the display.
- When the clock is not set, "CLOCK" and "ADJUST" appear alternately on the display. Set the clock first.

ON - AM 7:00 ⊕

Press the ►► or ◄◄ button on the Unit to set the hour you want the Unit to come on.

Pressing the ►► button moves the time forwards and pressing the ◄◄ button moves it backwards. Hold down the button to move the time rapidly.

ON - AM 10:00 ⊕

2. Press the TIMER button.  
The minute digits of the ON time blink on the display.

ON AM 10:00 ⊕

Set the minute you want the Unit to come on, using the ►► or ◄◄ button.

ON AM 10:15 ⊕

### 2 Setting the OFF time (Example: PM 1:30).

1. Press the TIMER button.  
The hour digit of the OFF time blinks on the display. (The same time as the ON time will be automatically set.)

OFF - AM 10:15 ⊕

Set the hour you want the Unit to be turned off, using the ►► or ◄◄ button.

OFF - PM 1:15 ⊕

2. Press the TIMER button.  
The minute digits of the OFF time blink on the display.

OFF PM 1:15 ⊕

Set the minute you want the Unit to be turned off, using the ►► and ◄◄ buttons.

OFF PM 1:30 ⊕

### 3 Selecting the music source.

1. Press the TIMER button.  
The "TUNER" or "CD" blinks on the display.
2. Press the ►► or ◄◄ button to select the music source you want to listen to.  
The display changes as shown below.  
**TUNER◄◄CD◄◄(back to the beginning)**

### 4 Setting the volume level.

1. Press the TIMER button.  
The current volume setting blinks on the display.
2. Press the ►► or ◄◄ button to select the volume level.  
-- :The current volume level will be used.  
0 to 50 :When the timer is turned on, the Volume will be automatically set to the selected level.

VOLUME -15 ⊕

### 5 Press the TIMER button.

The timer setting is completed and the display returns to the display before you set the Timer. The Timer indicator remains lit.

### 6 Before turning off the System, prepare the music source selected in step 3.

TUNER: Tune in to the desired station.

CD: Insert a CD. (Playback will start from the first track at Timer on.)

### 7 Press the POWER button to turn off the System.

In standby mode, you can see the Timer indicator ( ⊕ ) on the display.

- When the timer turns on, the Timer indicator starts blinking and the prepared source in step 6 will be played.

**To cancel the timer**, press the TIMER button. The Timer indicator ( ⊕ ) goes out on the display.

**To re-activate the cancelled timer**, press the TIMER button to light the Timer indicator ( ⊕ ).

At this time, you can see the current timer settings. Each setting appears on the display for two seconds in the order of ON time, OFF time, music source and volume.

**To change the timer setting**, repeat the setting procedure from the beginning.

### ⚠ CAUTION:

- If the System is unplugged, or a power failure occurs, the timer setting will be lost. You will need to reset the clock first, then the timer.

## Setting the SLEEP Timer

### (Using the Remote Control)

Use the Sleep Timer to turn the System off after a certain number of minutes when it is playing. By setting the Sleep Timer, you can fall asleep to music and know that your System will turn off by itself rather than play all night.

- You can only set the Sleep Timer when the System is on and a source is playing.

**1 Play a CD or tune in to the desired station.**

**2 Press the SLEEP button on the Remote Control.**

The “SLEEP” indicator lights up.

- When the clock is not set, “CLOCK” and “ADJUST” appear alternately on the display. Set the clock at first.

**3 Set the length of time you want the source to play before shutting off.**

- Each time you press the SLEEP button, it changes the number of minutes shown on the display in this sequence:

**10 → 20 → 30 → 60 → 90 → 120 → Cancelled → (back to the beginning)**

The selected number of minutes for the Sleep Timer will stop blinking five seconds later and the display returns to the original one before setting the Sleep Timer. (The display is dimmed.)

The System is now set to turn off after the number of minutes you set.

### To Confirm the Sleep Time:

When the SLEEP button is pressed, the remaining sleep time is displayed. Wait until the display returns to the original display.

### To Cancel the SLEEP Timer Setting:

Press the SLEEP button until the “SLEEP” indicator goes out on the display.

Turning off the System also cancels the SLEEP Timer.

- If you are setting the Daily Timer, the System will be turned on at the set time to wake you up.

# Care And Maintenance

Handle your CDs carefully, and they will last a long time.

## Compact Discs

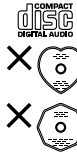

- Only CDs bearing this mark can be used with this System. However, continued use of irregular shape CDs (heart-shape, octagonal, etc.) can damage the System.



- Remove the CD from its case by holding it at the edges while pressing the case's center hole lightly.
- Do not touch the shiny surface of the CD, or bend the CD.



- Put the CD back in its case after use to prevent warping.
- Be careful not to scratch the surface of the CD when placing it back in the case.
- Avoid exposure to direct sunlight, temperature extremes, and moisture.



- A dirty CD may not play correctly. If a CD does become dirty, wipe it with a soft cloth in a straight line from center to edge.

## CAUTION:

- Do not use any solvent (for example, conventional record cleaner, spray thinner, benzene, etc.) to clean a CD.

## General Notes

In general, you will have the best performance by keeping your CDs and the mechanism clean.

- Store CDs in their cases, and keep them in cabinets or on shelves.
- Keep the System's Top Cover closed when not in use.

## Cleaning the unit

- Stains on the unit  
Should be wiped off with a soft cloth. If the unit is heavily stained, wipe it with a cloth soaked in water-diluted neutral detergent and wrung well, then wipe clean with a dry cloth.
- Since the unit may deteriorate in quality, become damaged or get its paint peeled off, be careful about the followings.
  - DO NOT wipe it with a hard cloth.
  - DO NOT wipe it strong.
  - DO NOT wipe it with thinner or benzene.
  - DO NOT apply any volatile substance such as insecticides to it.
  - DO NOT allow any rubber or plastic to remain in contact with it for a long time.

## Cleaning the Lens

If the lens in the CD pickup is dirty, dropout, etc., could degrade sound.

Open the Top Cover and clean the lens as shown.

- Use a blower (available from a camera store) to blow dust off the lens.

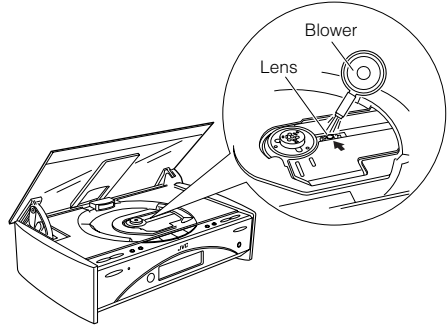

- If there are fingerprints, etc. on the lens, gently wipe clean with a cotton swab.

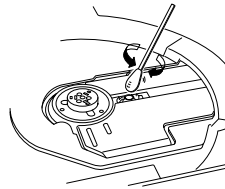

## Moisture Condensation



Moisture may condense on the lens inside the System in the following cases:

- After turning on heating in the room.
- In a damp room.
- If the System is brought directly from a cold to a warm place.

Should this occur, the System may malfunction. In this case, leave the System turned on for a few hours until the moisture evaporates, unplug the AC power cord, and then plug it in again.

# Troubleshooting

- If you are having a problem with your System, check this list for a possible solution before calling for service.
- If you cannot solve the problem from the hints given here, or the System has been physically damaged, call a qualified person, such as your dealer, for service.

Symptom	Possible Cause	Action
No sound is heard.	<ul style="list-style-type: none"><li>• Connections are incorrect, or loose.</li><li>• Headphones are connected.</li></ul>	<ul style="list-style-type: none"><li>• Check all connections and make corrections. (See pages 4 to 8.)</li><li>• Disconnect the headphones.</li></ul>
Poor radio reception	<ul style="list-style-type: none"><li>• The antenna is disconnected.</li><li>• The AM Loop Antenna is too close to the System.</li><li>• The FM Wire Antenna is not properly extended and positioned.</li></ul>	<ul style="list-style-type: none"><li>• Reconnect the antenna securely.</li><li>• Change the position and direction of the AM Loop Antenna.</li><li>• Extend FM Wire Antenna to the best reception position.</li></ul>
The CD skips.	The CD is dirty or scratched.	Clean or replace the CD.
The CD does not play.	The CD is upside down.	Put the CD in with the label side up.
Unable to operate the Remote Control.	<ul style="list-style-type: none"><li>• The path between the Remote Control and the sensor on the Unit is blocked.</li><li>• The batteries have lost their charge.</li></ul>	<ul style="list-style-type: none"><li>• Remove the obstruction.</li><li>• Replace the batteries.</li></ul>
Operations are disabled.	The built-in microprocessor has malfunctioned due to external electrical interference.	Unplug the System then plug it back in.
NO DISC appears.	There is no disc in the tray, or CD, CD-R or CD-RW that hasn't yet been finalized (including blank discs) has been inserted.	Insert a CD, CD-R or CD-RW that has been finalized.

# Specifications

## Amplifier

Output Power	38 W (19 W + 19 W) at 4 ohms (Max.) (for Canada)
Input Sensitivity/Impedance (1 kHz)	
MD/AUX IN	500 mV/47 kohms
Output Sensitivity/Impedance (1 kHz)	
MD/AUX OUT	500 mV/5 kohms
CD DIGITAL OUT (Optical out)	-21 dBm - -15 dBm
Speaker terminals	4 - 16 ohms
Subwoofer out	230mV/19kohms
Phones	16 ohms - 1 kohm
	0 - 15 mW/ch output into 32 ohms

## CD Player

Signal-To-Noise Ratio	90 dB
Wow And Flutter	Unmeasurable

## Tuner

FM Tuner	
Tuning Range	87.5 - 108.0 MHz
AM Tuner	
Tuning Range	530 - 1 710 kHz

## Center Unit (FS-SD550/SD770/SD990)

Dimensions	300mm × 75mm × 215mm (W/H/D) (11 - <sup>13</sup> / <sub>16</sub> " × 3" × 8 - <sup>1</sup> / <sub>2</sub> " )
Mass	Approx. 3.0 kg (6.7 lbs)

## Speaker Specifications (each unit)

### FS-SD550

Speakers	8 cm cone
Impedance	4 ohms
Dimensions	109mm × 217mm × 165mm (W/H/D) (4 - <sup>5</sup> / <sub>16</sub> " × 8 - <sup>9</sup> / <sub>16</sub> " × 6 - <sup>1</sup> / <sub>2</sub> " )
Mass	1.5kg (3.4 lbs)

### FS-SD770

Speakers	8 cm cone
Impedance	4 ohms
Dimensions	120mm × 246mm × 162mm (W/H/D) (4 - <sup>3</sup> / <sub>4</sub> " × 9 - <sup>11</sup> / <sub>16</sub> " × 6 - <sup>7</sup> / <sub>16</sub> " )
Mass	1.4kg (3.1 lbs)

### FS-SD990

Speakers	8 cm cone
Impedance	4 ohms
Dimensions	120mm × 246mm × 162mm (W/H/D) (4 - <sup>3</sup> / <sub>4</sub> " × 9 - <sup>11</sup> / <sub>16</sub> " × 6 - <sup>7</sup> / <sub>16</sub> " )
Mass	1.4kg (3.1 lbs)

## Accessories

Power Cord (1)
AM Loop Antenna (1)
Remote Control (1)
Batteries R6P (SUM-3)/AA (15F) (2)
FM Wire Antenna (1)
Speaker Cords (2)

## Power Specifications

Power Requirements	AC 120 V ~ , 60 Hz
Power Consumption	28 watts (power on mode) 2.1 watts (in Standby mode)

*Design and specifications are subject to change without notice.*





**JVC**  
VICTOR COMPANY OF JAPAN, LIMITED